



LUMINOSITY
DISPLAY LIGHTING & ACCESSORIES
ISSUE 1



LUMINA 1

Product Code:
LUM-1-C Chrome
LUM-1-B Silk Black

12 Volt spot light with goose neck arm, adjustable head and tail. Light includes 110 volt UL approved transformer, 50 watt bulb and universal fittings kit.

Stats
14" long (355.6 mm) from end to end



LUMINA 2

Product Code:
LUM-2
(For use with banner stands only)

12 Volt spot light with curved arm and adjustable head. Light includes 110 volt UL approved transformer, 35 watt bulb and pole clamp.

Stats
12" long (304.8 mm) from end to end

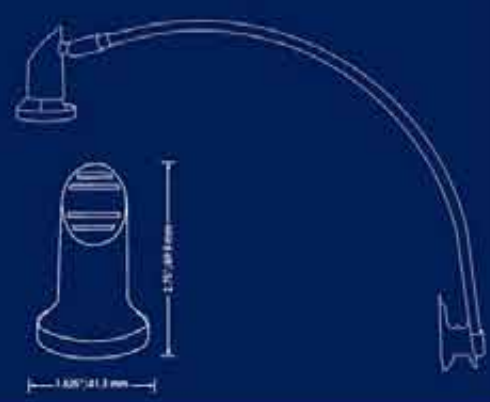

LUMINA 3

Product Code:
LUM-3
Available with Silver Chrome arm and Silk Black head.

12 Volt spot light with telescopic adjustable arm and adjustable head and tail. Light includes 110 volt UL approved transformer, 50 watt bulb and universal fittings kit.

Stats
Telescoping arm extends from 10"-24" (254-609.4 mm)

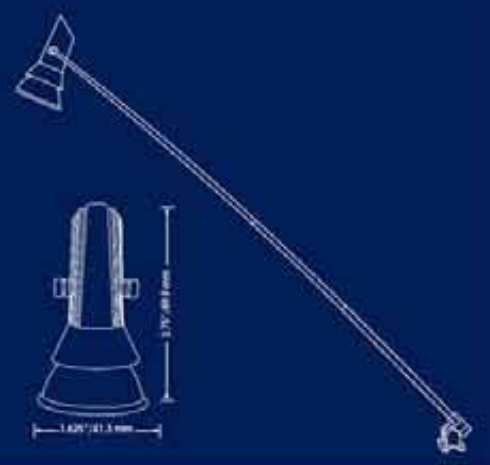

LUMINA 4

Product Code:
LUM-4
Available in a Silver Chrome finish.

12 Volt spot light with telescopic adjustable arm and adjustable head and tail. Light includes 110 volt UL approved transformer, 50 watt bulb and universal fittings kit.

Stats
Telescoping arm extends from 10"-24" (254-609.4 mm)

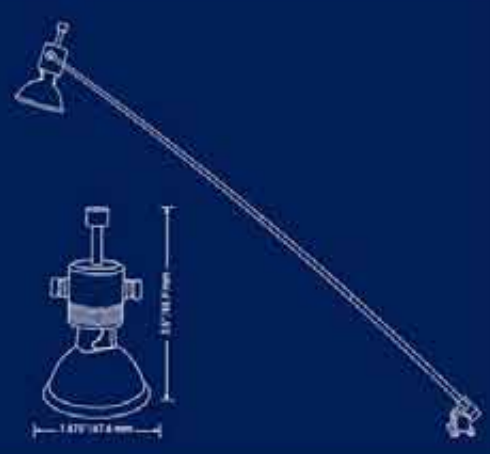

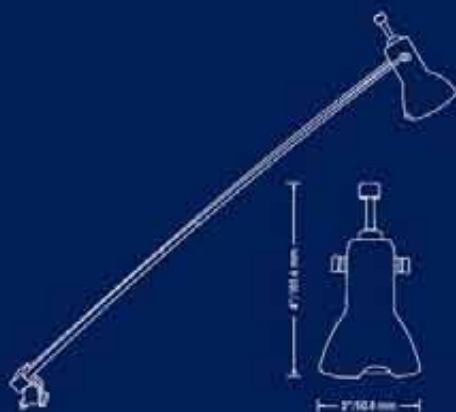

LUMINA 5

Product Code:

LUM-5

Available in a Silver Chrome finish.

12 Volt spot light with telescopic adjustable arm and adjustable head and tail. Light includes 110 volt UL approved transformer, 50 watt bulb and universal fittings kit.

Stats

Telescoping arm extends from 10"-24" (254-609.4 mm)

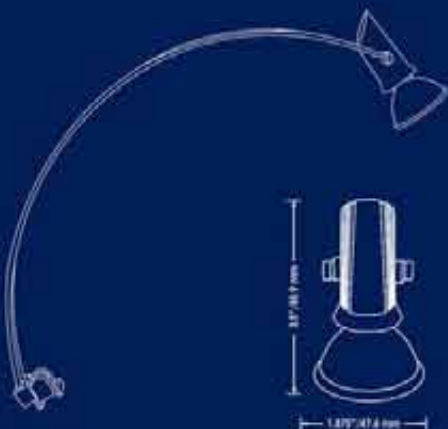

LUMINA 6

Product Code:

LUM-6

Available in a Silk Black finish.

12 Volt spot light with curved arm and adjustable head and tail. Light includes 110 volt UL approved transformer, 50 watt bulb and universal fittings kit.

Stats

16.5" long (419.1 mm) from end to end

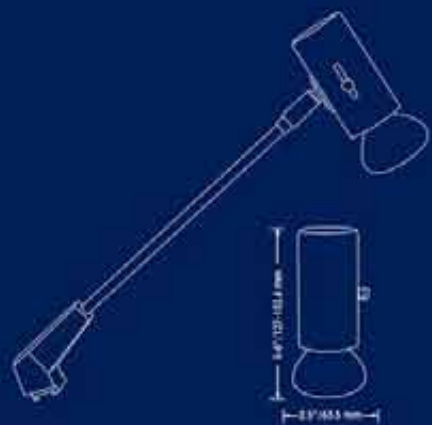

LUMINA 7

Product Code:

LUM-7

Available in a Silk Black finish.

110 Volt UL approved incandescent spot light with straight arm and adjustable head. Light includes 50 watt bulb and mounting brackets for popup display systems.

Stats

17.75" long (450.9 mm) from end to end

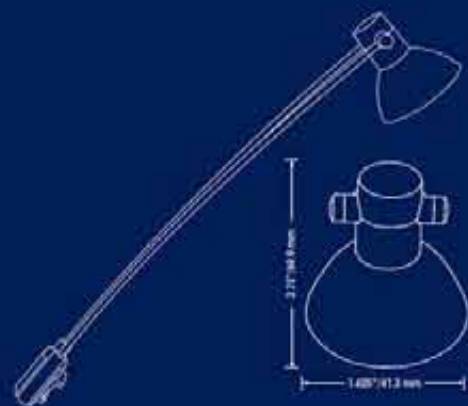

LUMINA 8

Product Code:

LUM-8-B Silk Black
LUM-8-C Painted Silver

12 Volt spot light with straight arm and adjustable head. Light includes 110 volt UL approved transformer, 50 watt bulb and universal fittings kit.

Stats

17" long (431.8 mm) from end to end





LUMINA 9

Product Code:

LUM-9

Available in a painted Silver finish.

12 Volt spot light with straight arm and adjustable head and tail. Light includes 110 volt UL approved transformer, 50 watt bulb and universal fittings kit.

Stats

19.5" long (495.3 mm) from end to end.

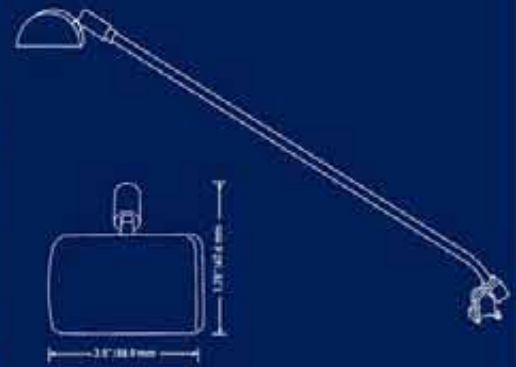

LUMINA 10

Product Code:

LUM-10

Available in a painted Silver finish.

12 Volt spot light with straight arm and adjustable head and tail. Light includes 110 volt UL approved transformer, 50 watt bulb and universal fittings kit.

Stats

20" long (508 mm) from end to end.

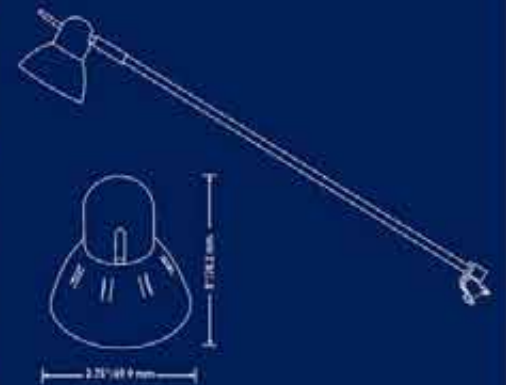

LUMINA 11

Product Code:

LUM-11

Available in a painted Silver finish.

12 Volt spot light with straight arm and adjustable head and tail. Light includes 110 volt UL approved transformer, 50 watt bulb and universal fittings kit.

Stats

19" long (482.6 mm) from end to end.

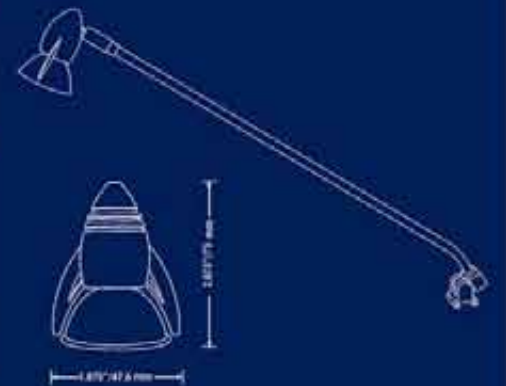

LUMINA 12

Product Code:

LUM-12-C

Arm is a painted Silver finish, head is a high shine Chrome finish.

12 Volt spot light with focus angle arm and adjustable head and tail. Light includes 110 volt UL approved transformer, 50 watt bulb and universal fittings kit.

Stats

18.5" long (470 mm) from end to end.

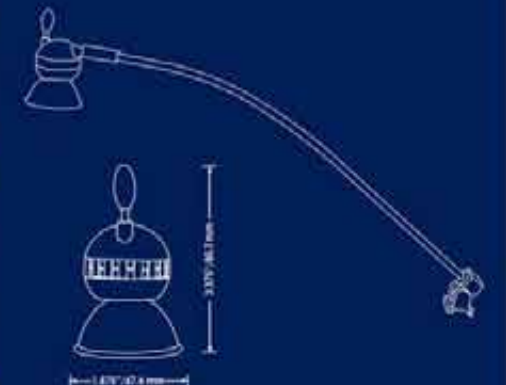

LUMINA 13

Product Code:
LUM-13

Available in a painted Silver finish.

12 Volt spot light with straight arm and adjustable head and tail. Light includes 110 volt UL approved transformer, 50 watt bulb and universal fittings kit.

Stats

20" long (508 mm) from end to end.

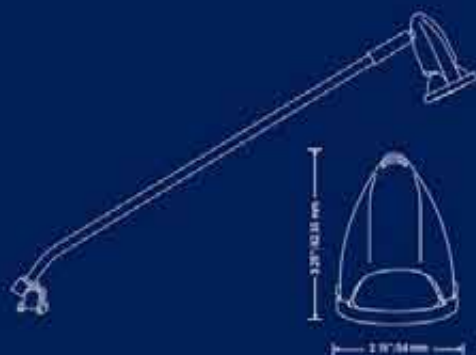

LUMINA 200

Product Code:
LUM-200-ORL

Available in a Silk Black finish.

110 Volt ETL approved wall-washer floodlight with a straight arm and adjustable head. Light includes 200 watt halogen bulb.

Stats

19.5" long (495.3 mm) from end to end.

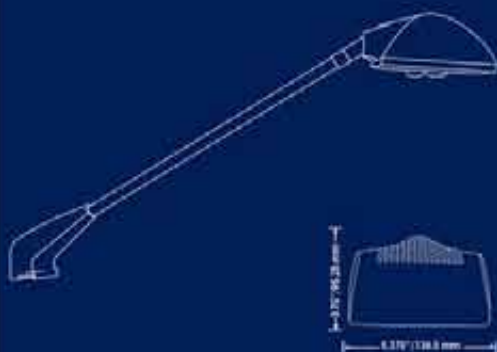

UNIVERSAL FITTINGS KIT

Product Code:
UNI-LT-CLP

A Selection of fixtures that allow you to fit your Lumina lights onto practically any display product (except Lumina 2).

Kit includes: A UNIVERSAL CLAMP for fitting onto vertical and horizontal poles, panels, banner stands, truss, pipe, counters, Popups, podiums, etc and (2) POPUP BRACKETS which allow you to mount your Lumina onto the scissors of most known popup display systems.



LUMINA BULB KIT

Product Code:
LUM-BULB

Pack of 2 spare 50 watt bulbs in convenient foam-lined EVA case.

Wide range of additional bulbs for all Lumina lights are available. These bulbs will work with all 50 watt Lumina spot lights.





LUMINA TRK 1

Product Code:
LUM-TRK1-S
Available in a painted Silver finish.

12 Volt track light system. Kit includes 47.25" power track, 3 individual spot lights with adjustable heads, 110 volt UL approved transformer and (3) 50 watt bulbs.

Stats
47.25" long (1200.15 mm) from end to end.



LUMINA P1

Product Code:
LUM-P1
Available in a Brushed Silver Nickel finish.

12 Volt 'PUC down-lighter' system. Kit includes (2) angle adjustable PUC lights, connecting cables, 110 volt UL approved transformer and (2) 20 watt bulbs.

Stats
Light fixture is 2.37" wide & 3.12" high.



LUMINA P3

Product Code:
LUM-P3
Available in a Brushed Silver Nickel finish.

12 Volt 'PUC down-lighter' system. Kit includes (2) PUC lights, connecting cables, 110 volt UL approved transformer and (2) 50 watt bulbs.

Stats
Light fixture is 3.125" in diameter.



LUMINA P4

Product Code:
LUM-P4
Available in a Silver Chrome finish.

12 Volt 'PUC down-lighter' system. Kit includes (2) angle adjustable PUC lights, connecting cables, 110 volt UL approved transformer and (2) 35 watt bulbs.

Stats
Light fixture is 3.5" square.



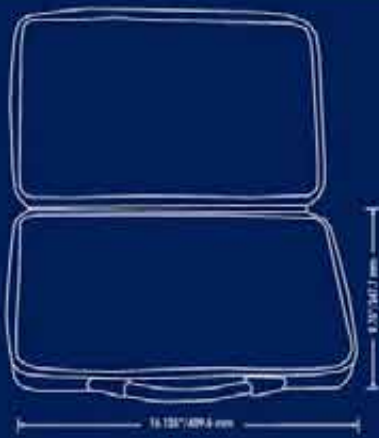

LUMINA FLD CASE

Product Code:
FLD-CASE
Available in textured black finish.

EVA case with foam-lined padded compartments. Stores (2) lights. Designed for use with most Lumina series lights. (Excluding Lumina 6)

Stats
EVA semi-rigid lighting case.

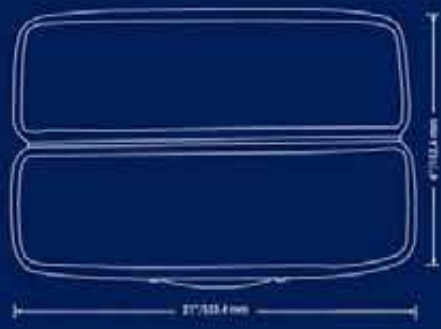

LUMINA SPT CASE

Product Code:
SPT-CASE
Available in textured black finish.

EVA case with foam-lined padded compartments. Stores and transports (2) lights. Can be used with all the Lumina series lights.

Stats
EVA semi-rigid lighting case.

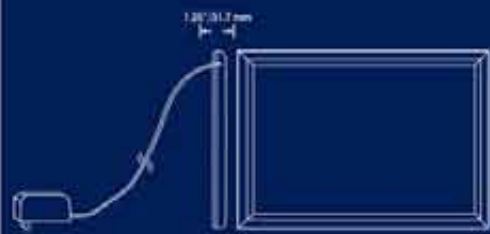

SYNTHESIS FAST-MAG

Product Codes:
SYNTH-FM-1 (graphic size: 8.25\"/>

12 Volt, wall mountable lightbox, featuring a magnetic aluminum frame. Available in (4) sizes, kits include built-in CCFL bulbs, connecting cable and 110 volt UL approved transformer with a back & side plug ports.

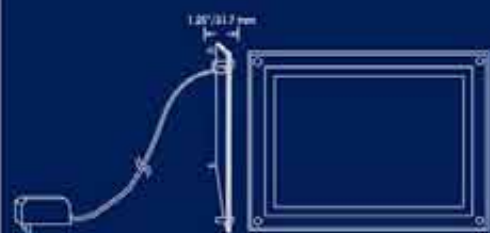

SYNTHESIS PRO CCFL

Product Codes:
SYNTH-PR-1 (graphic size: 8\"/>

12 Volt, wall mountable or tabletop lightbox, featuring an edge lit acrylic frame. Available in (4) sizes, kits include built in CCFL bulbs, connecting cable and 110 volt UL approved transformer. Synthesis 3- tabletop use only, Synthesis 4- wall mount only.



